



CLOUD 7

PRODUKTDATEN

PRODUCT INFORMATION
INFORMATION PRODUITS

Bretz
TRUE CHARACTERS

Ich liebe das Extreme. Das gibt mir den richtigen Kick. So kann ich mich selbst spüren und meinen Willen dazu bringen, über die eigenen Grenzen hinaus zu gehen. Kompromisse interessieren mich in diesen Momenten nicht. Ich bin stolz auf das was ich bin und darauf wer ich bin – stolz auf meine Ecken und Kanten, auf meine Unabhängigkeit und darauf, meinen eigenen Weg zu gehen. Don't be afraid of extremes.

WHAT I'M
LOOKING
FOR ISN'T
OUT THERE,
IT'S IN ME



Z 154 CLOUD 7 ▶ 318 CM ◀ 318 CM ▲ 78 CM
STOFF · TISSU · FABRIC 66 2085

FACTS & HIGHLIGHTS

- Cloud 7 ist der ultimative Bretz-Klassiker
- Kassettenheftung in höchster Manufaktur-Qualität
- Baukastensystem mit zwei Sitztiefen für mehr Individualität
- Sooooo bequem
- Kein 90° Winkel
- unkonventionelle Grundrisse
- stabiles Holzgestell mit Nosagfederung und Taschenfederkern - darüber dauerelastische premium Kaltschäume & Polstervlies
- Füße: Kunststoffgleiter H: 5cm , Twista H: 10 cm



Z 154 CLOUD 7 ▶ 318 CM ◀ 318 CM ▲ 78 CM
STOFF · TISSU · FABRIC 66 2085

**WHAT I'M
LOOKING
FOR ISN'T
OUT THERE,
IT'S IN ME**



G 154 CLOUD 7 ▶ 258 CM ▼ 177 CM ▲ 78 CM
STOFF · TISSU · FABRIC 66 BOH67

I just love the extreme. It's the kick - I can't get enough. It lets me feel the real me and concentrate all my willpower to go beyond my breaking point. You can't compromise at all in moments like these. I'm proud of what I am and who I am. Happy with all of my rough edges, satisfied about my self-sufficiency and the fact that I go my own way. Don't be afraid of extremes.

FACTS & FEATURES

- Cloud 7 is the epitome of the Bretz philosophy
- Premium, artisan-quality cassette upholstery
- Modular system with two seat depths
- Comfort that's out of this world
- Not a single right angle
- Sound wooden structure with with horizontal „Nosag“ and vertical „Bonnell“ spring systems
- Above that: Super-soft, long-lasting, multi-layer, made-to-measure cold foam composition and cosy polyester fleece
- Feet: Gliders h: 5 cm, Twista h: 10 cm



B 122 HANGOUT ▶ 87 CM ▼ 114-129 CM ▲ 115 CM
STOFF · TISSU · FABRIC 65 BOH67

C 122 HANGOUT ▶ 84 CM ▼ 63 CM ▲ 44 CM
STOFF · TISSU · FABRIC 65 BOH67



F 154 CLOUD 7 ▶ 252 CM ▼ 132 CM ▲ 78 CM
STOFF · TISSU · FABRIC 64 2960

CE QUE JE RECHERCHE EST EN MOI

J'adore l'extrême. Pour moi c'est un vrai coup de fouet. Cela me fait me sentir vrai, me pousse à aller au-delà de mes propres limites. Les compromis ne m'intéressent pas dans ces moments-là. Je suis fier de ce que je suis et de qui je suis - fier de toutes les aspérités de ma personnalité, de mon indépendance et de la voie qui est la mienne. Don't be afraid of extremes.

CARACTÉRISTIQUES & HIGHLIGHTS

- Cloud 7 est le classique Bretz par excellence
- Capitonnage à cassettes de la meilleure qualité artisanale
- Système modulaire avec deux profondeurs d'assise
- Tellement confortaaaaable
- Pas d'angle à 90 degrés
- Structures non-conventionnelles
- Châssis stable en bois et suspension à ressorts de type Nosag dit suspension à vague et ressorts Bonell.
- Sur l'assise et dans le dossier: Un garnissage de mousse de polyuréthane et une toison de polyester
- Patin rond h: 5 cm, Twista h: 10 cm



H 154 CLOUD 7 ▶ 94 CM ▼ 200 CM ▲ 93 CM
STOFF · TISSU · FABRIC 70 4042

CLOUD 7

154 • SINGLE ELEMENTS • LONGCHAIR

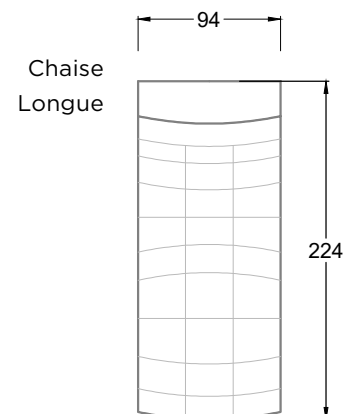
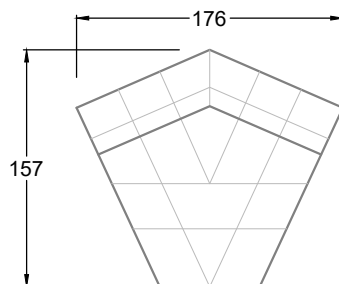
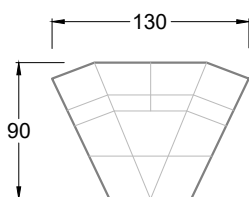
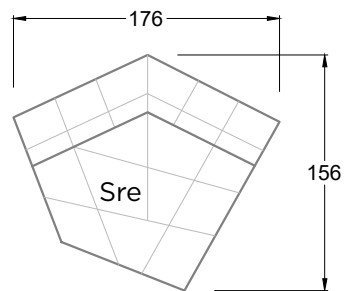
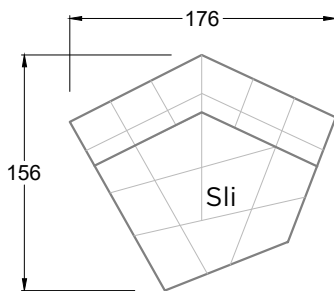
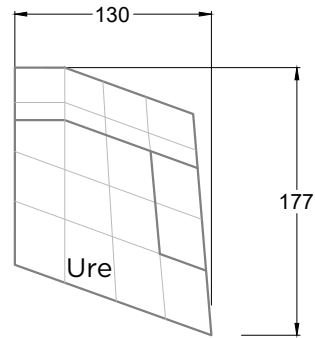
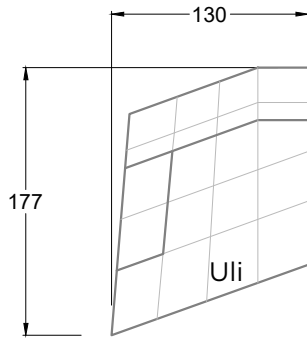
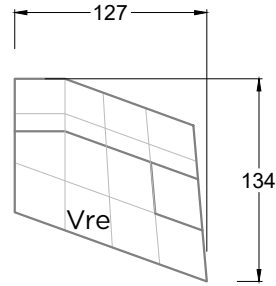
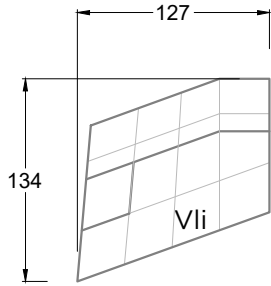
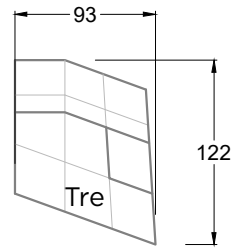
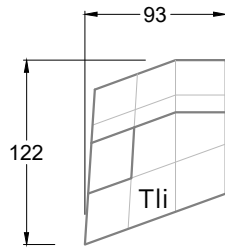

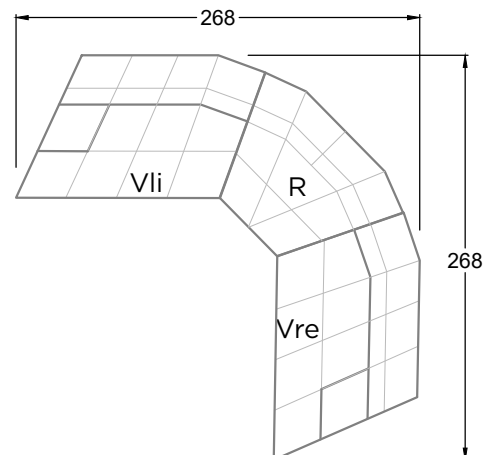
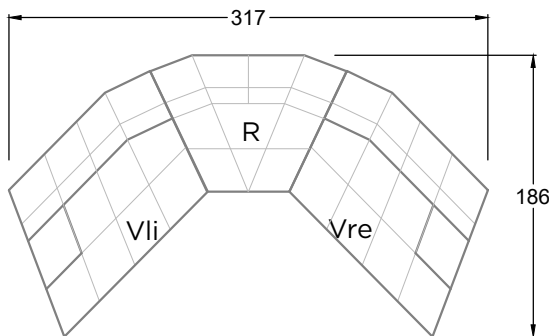
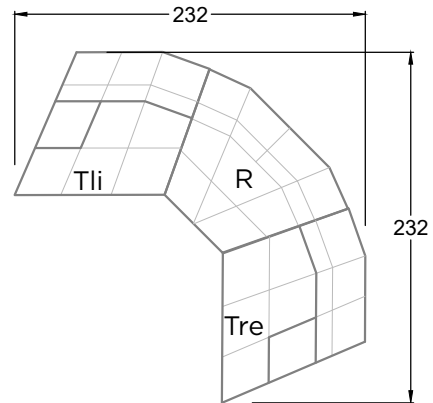
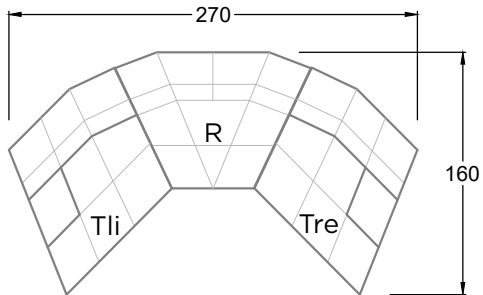
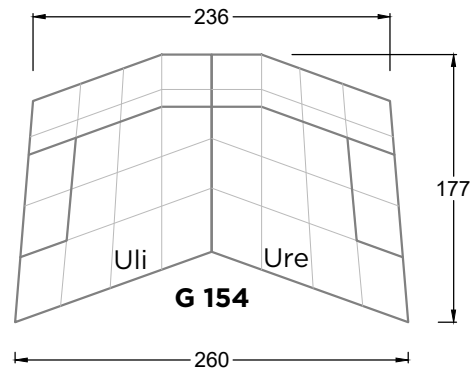
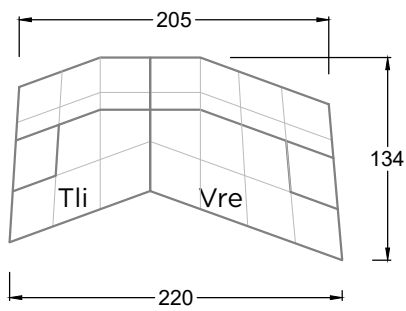
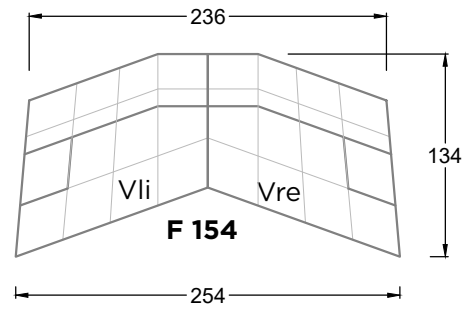
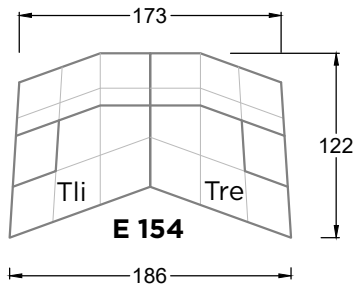

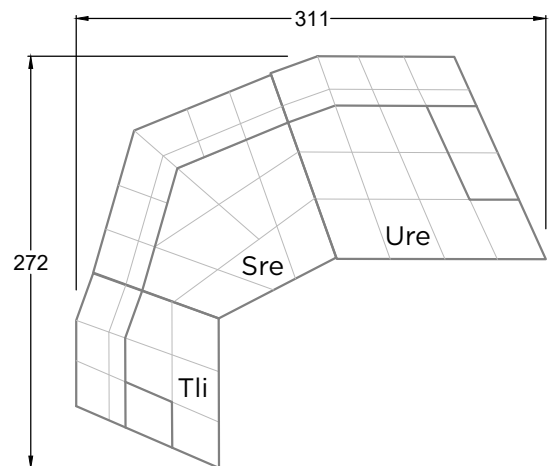
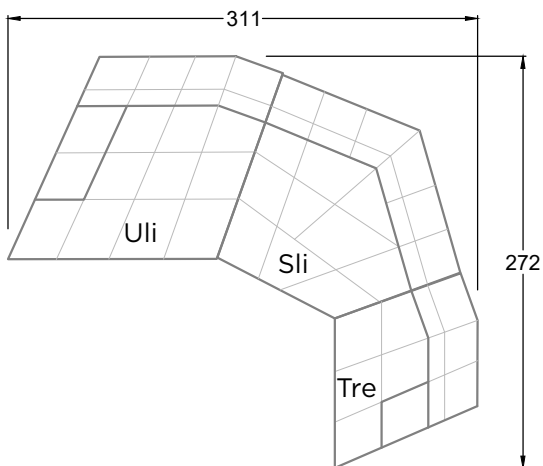
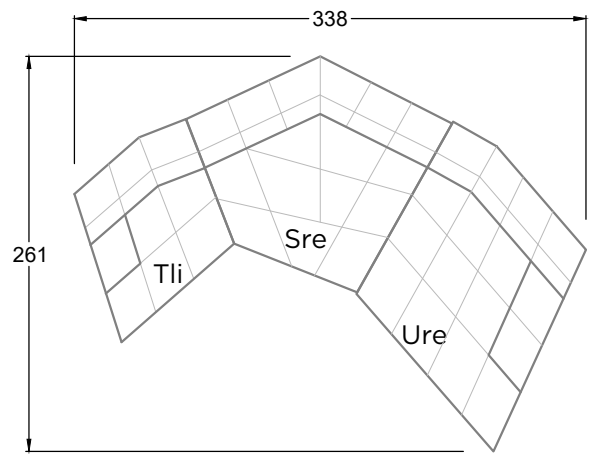
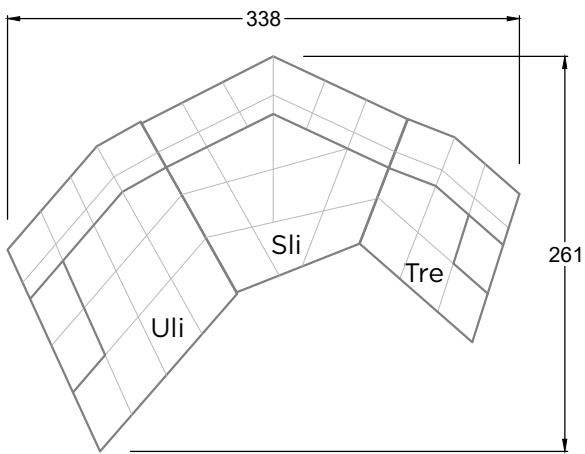
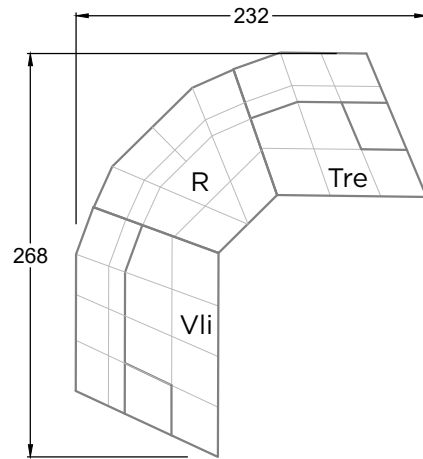
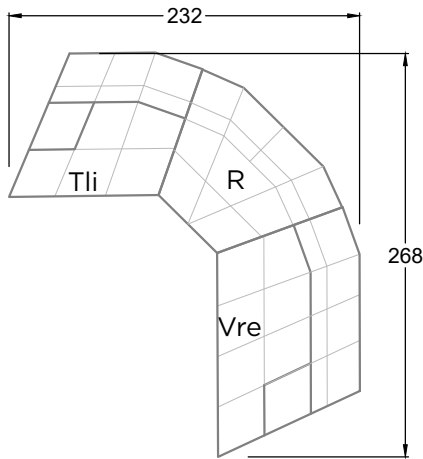
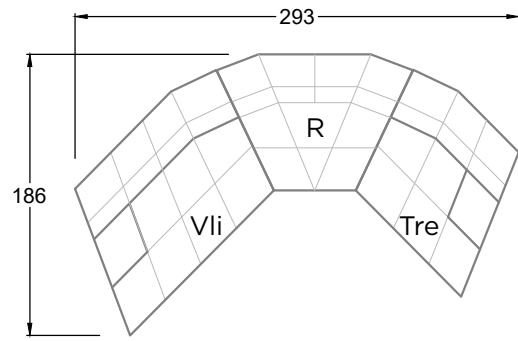
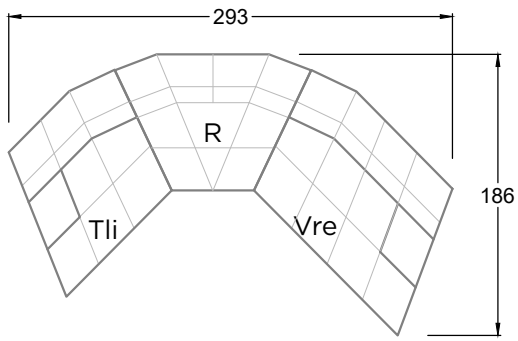

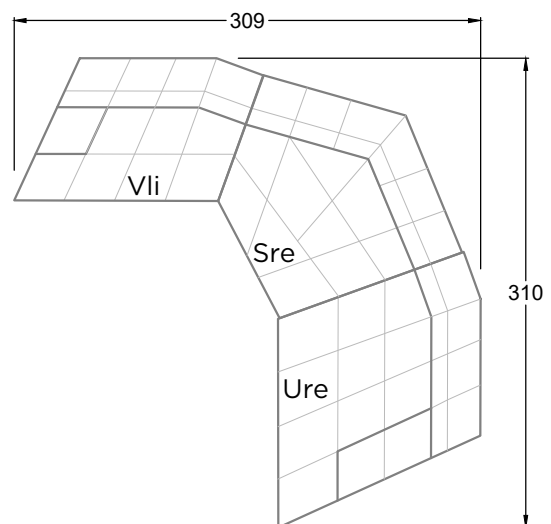
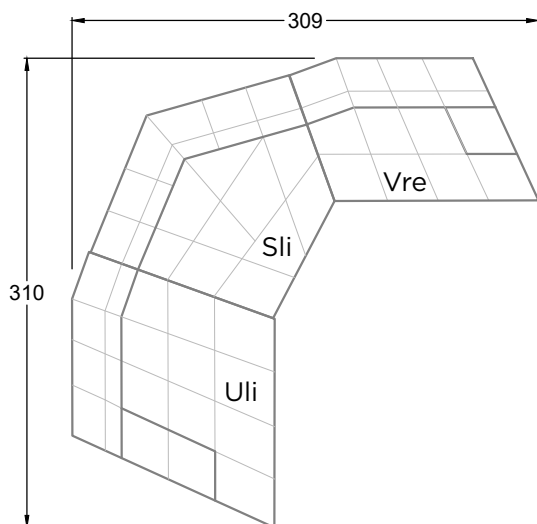
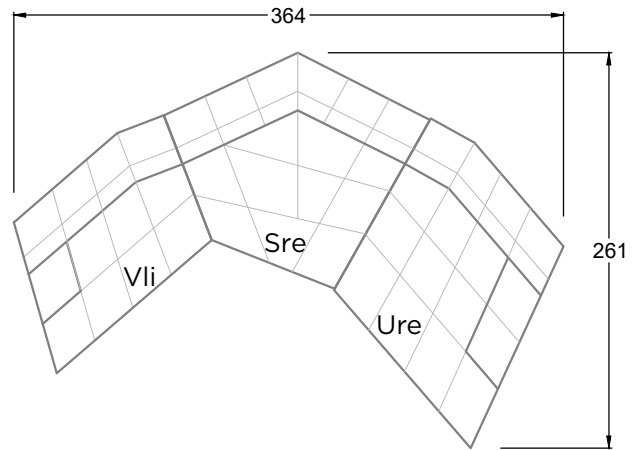
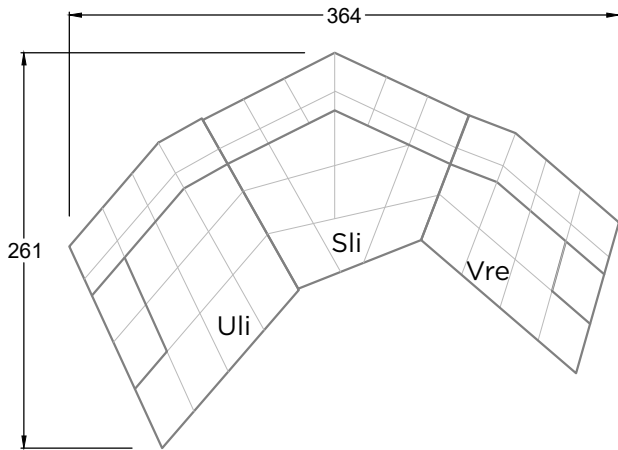
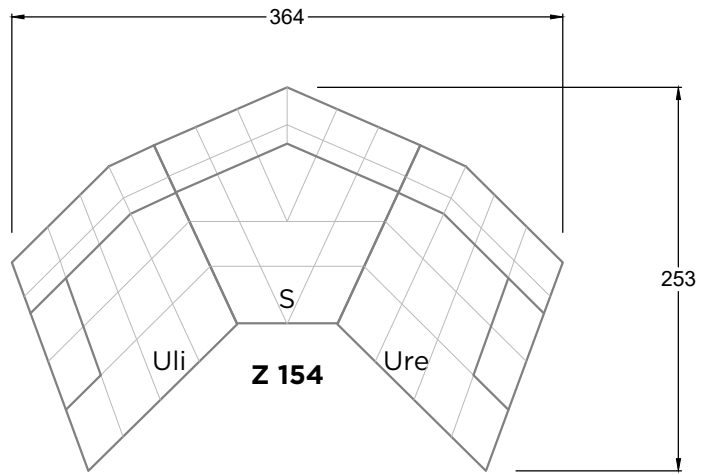
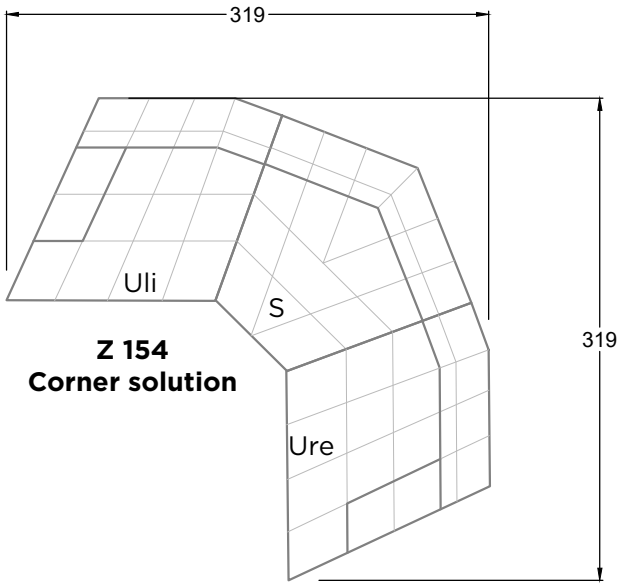

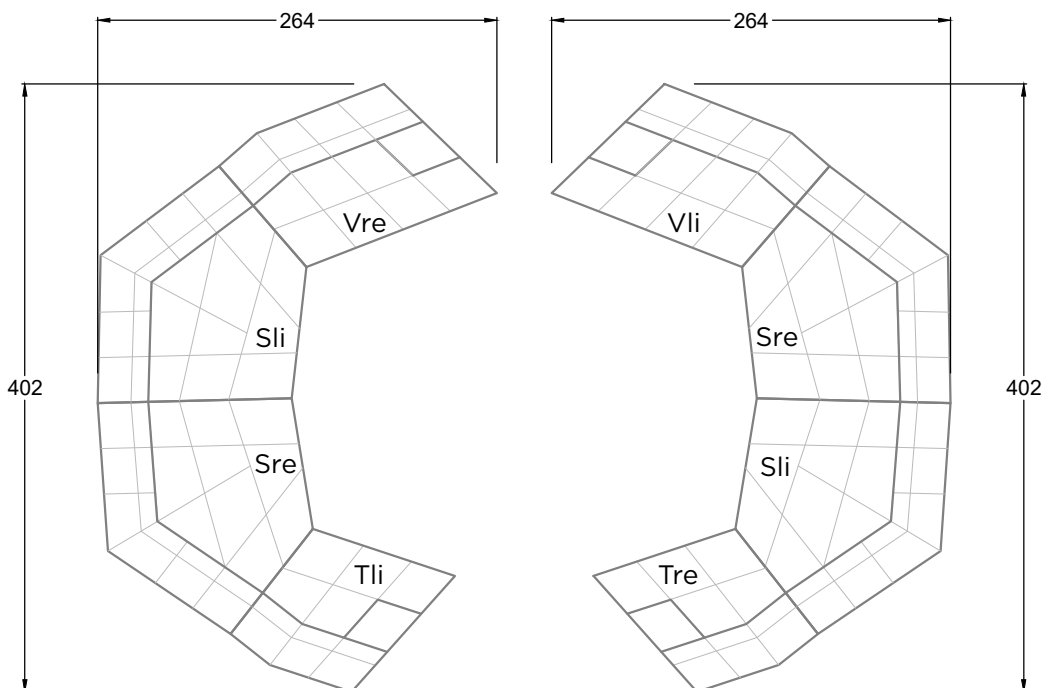
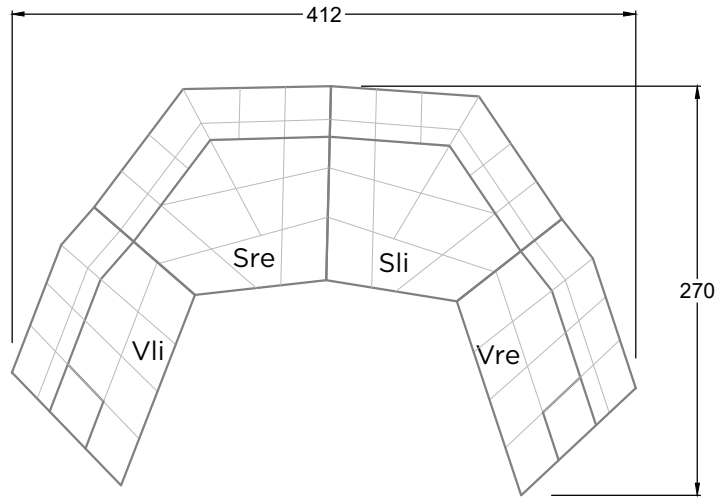
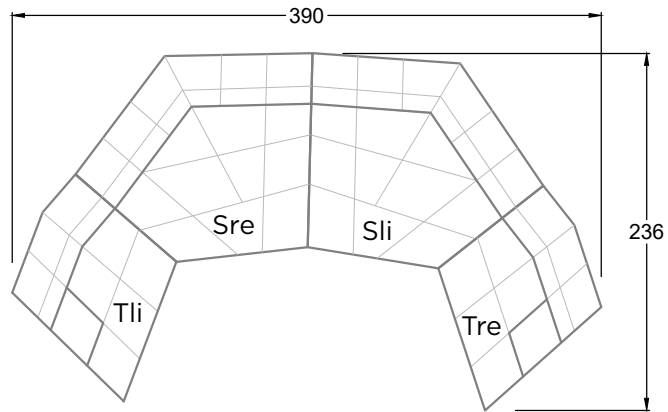

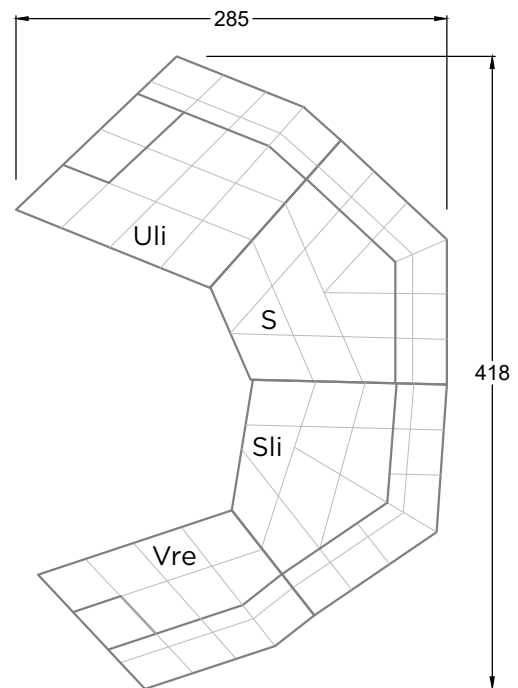
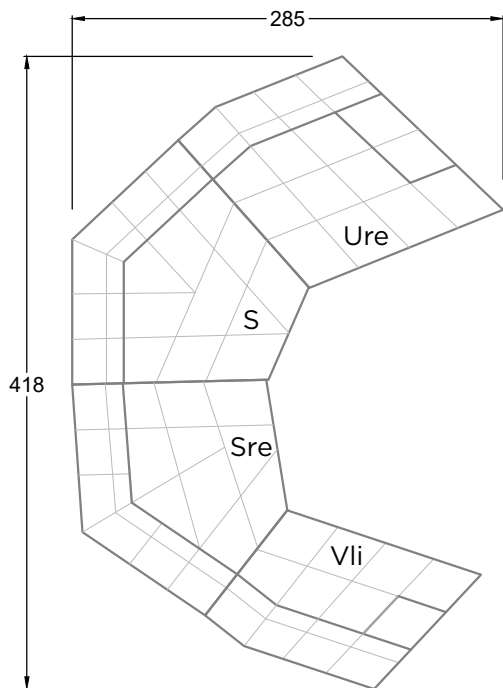
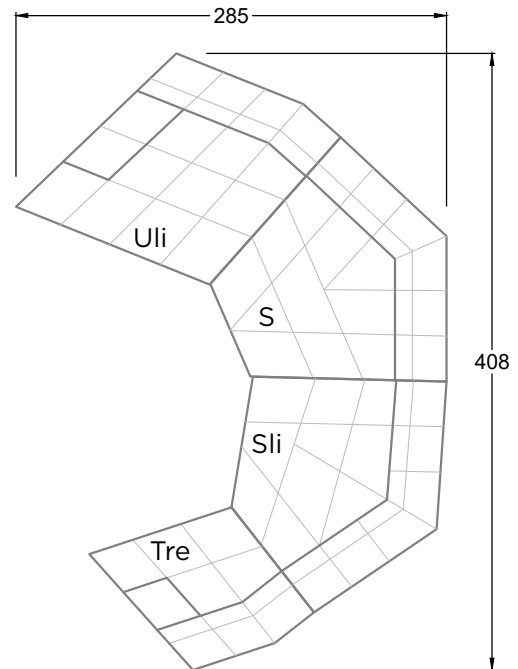
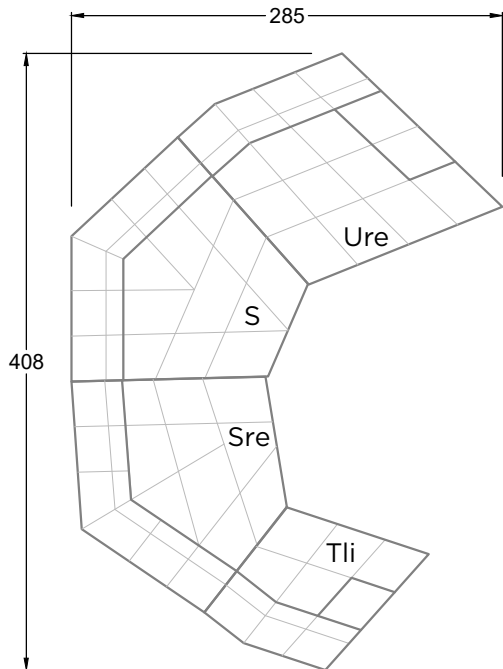
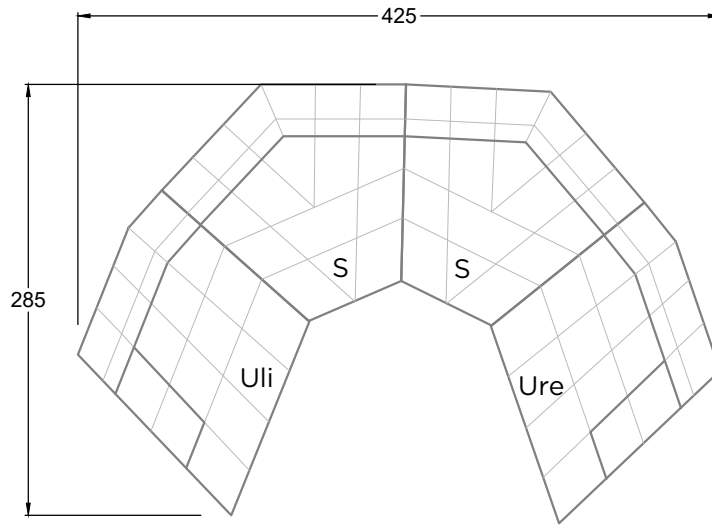

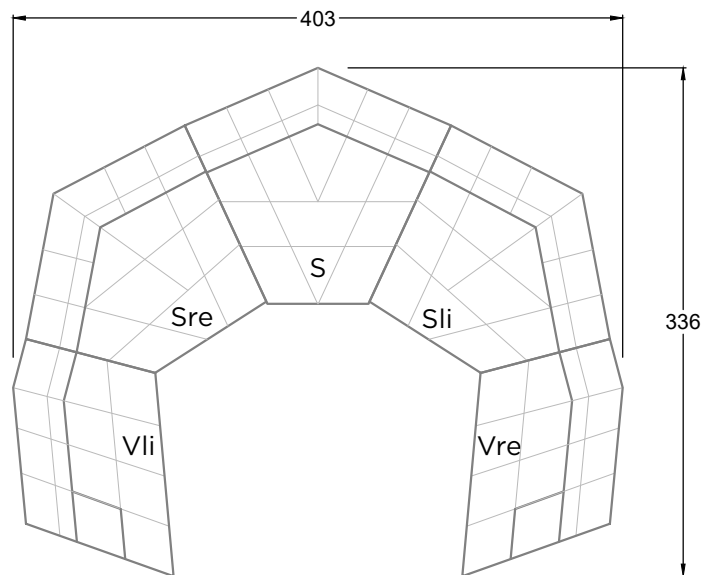
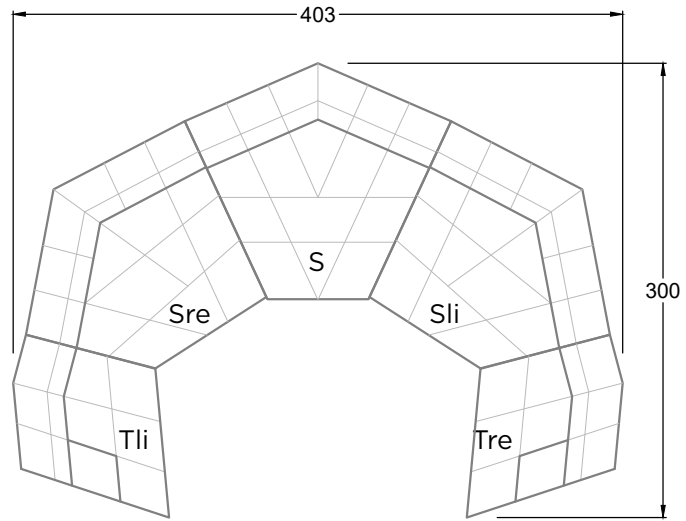

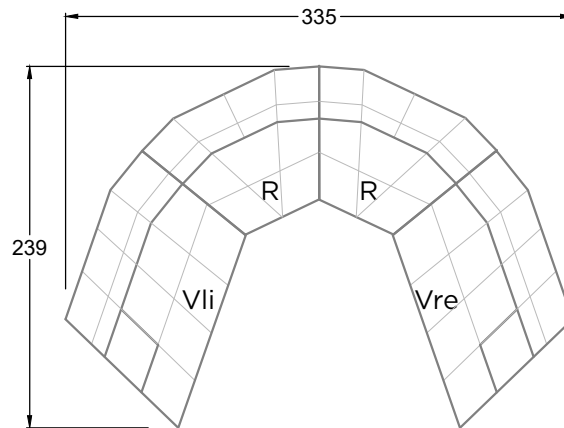
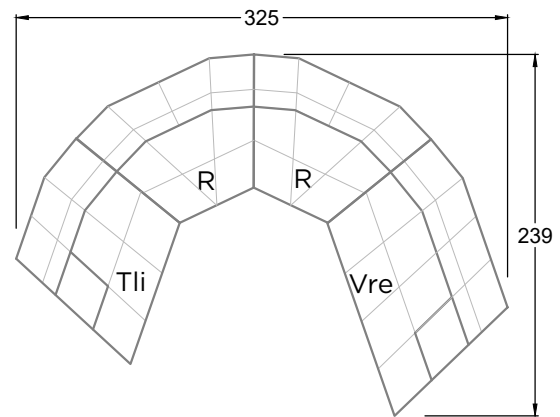
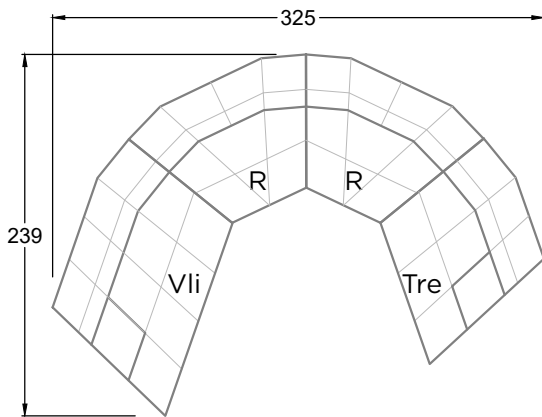
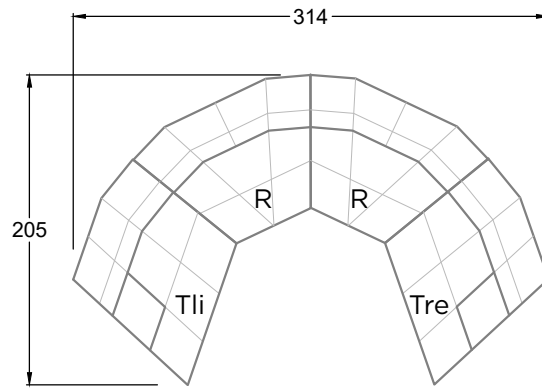

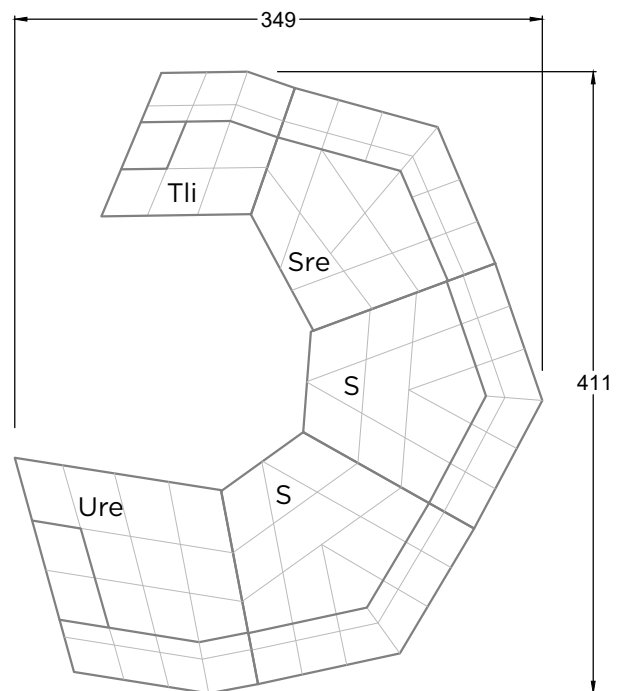
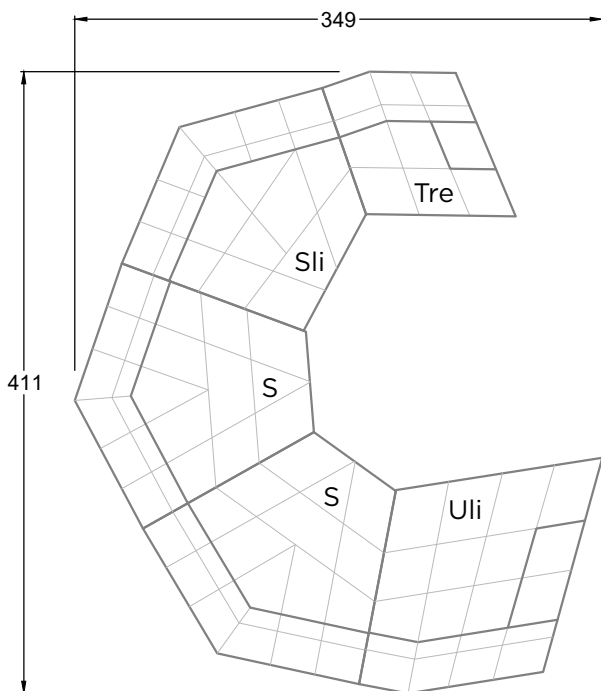
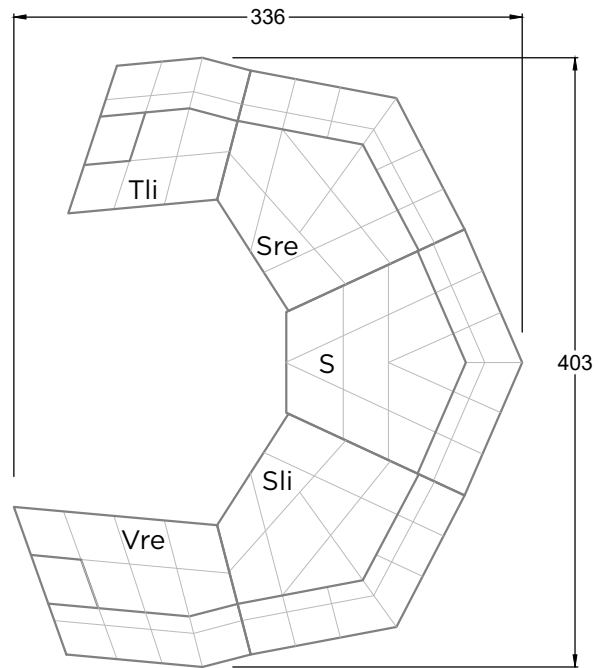
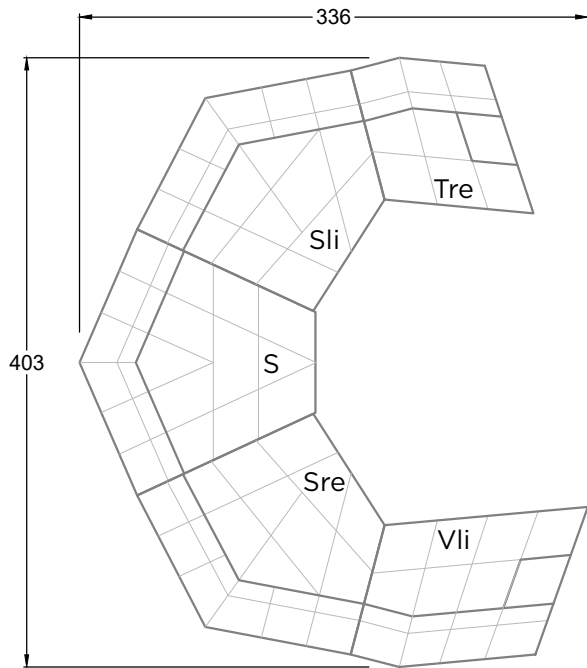

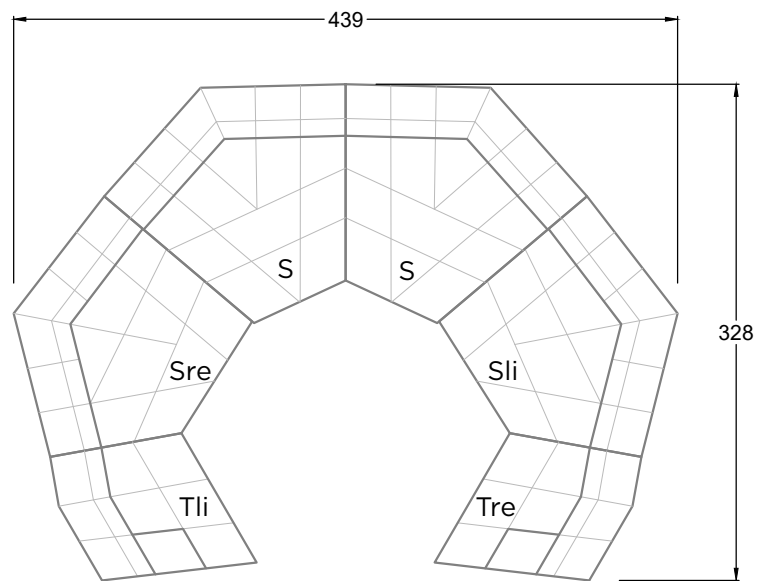
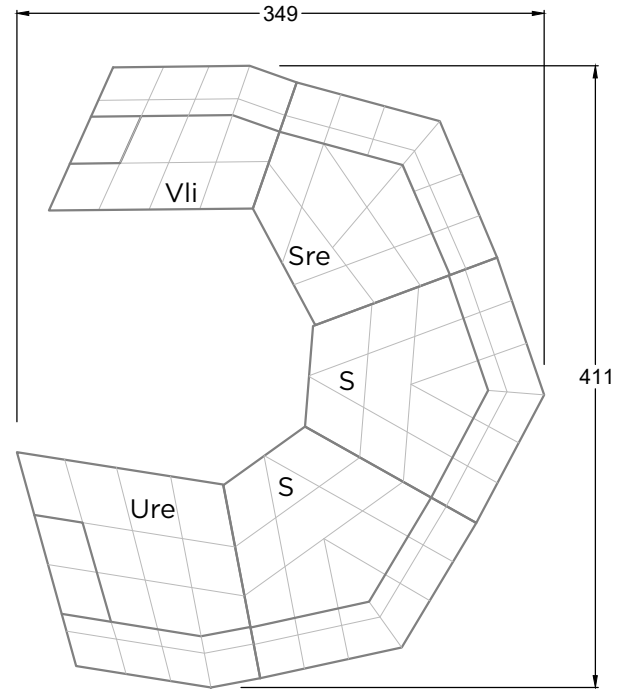
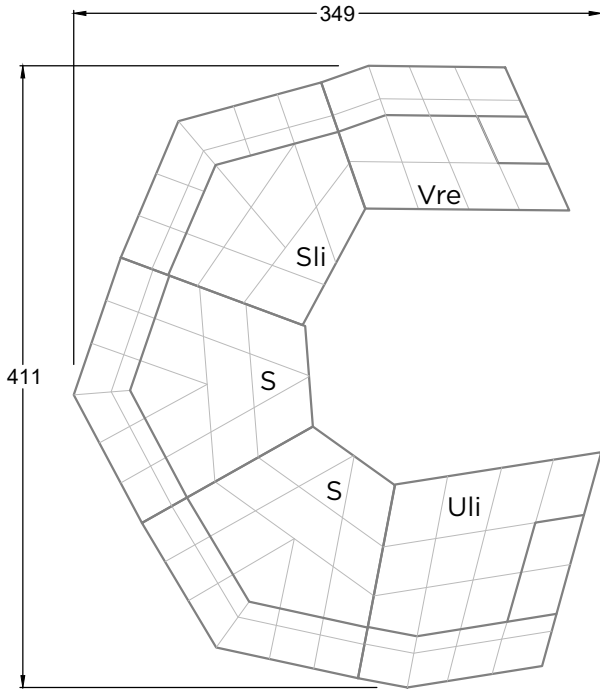

**BRETZ
GERMAN MANUFACTURE
SINCE 1895**

HEAD OFFICE & SHOWROOM:
ALEXANDER-BRETZ-STR. 2
D-55457 GENSINGEN
TEL +496727-895-0
E-MAIL INFO@BRETZ.DE

BRETZ SALES FLAGSHIPS & PARTNERS:
BRETZ.DE

Bretz
TRUE CHARACTERS